

LD81



High Power Miniature LED spotlight with Mounting Systems

Data sheet - Page 1



Design: Into Lighting Project: The Shard, London Product: LD81

The LD81 is a high power, miniature, adjustable LED spotlight. With its discreet design, and wide range of mounting options it is suitable for a huge variety of applications. Each mounting method is custom made to each projects requirements, allowing the designer to tailor the lighting layout for each display. The best method of specification for these spotlights and mounting systems is to send us a sketch of what is required. This can then be discussed and we will produce a project specification and quote.

Key Features

- Utilizes the latest LED technology with a typical CRI of 93 in warm white
- Broad range of uses includinn display, picture and sign lighting
- Compact design with high output
- Knuckle joint allows great flexibility in adjustment
- Custom made to suit exact specified dimensions
- Range of mounting options
- Precise beam control with a range of lenses
- Available with Switch, 0-10V, DMX, Dali or Mains dimmable drivers

Specification

Applications



Beam Angles	12°, 31°, 48°					
LED type	1 x Cree XPG2					
Colour temperature	2700K** / 3000K			5000K		
Drive Current (mA)	350	500	700	350	500	700
LED power* (W)	1.2W	1.7W	2.4W	1.2W	1.7W	2.4W
CRI (typical)	93	93	93	75	75	75
Forward voltage (V) ₁₀₀	3.0V	3.2V	3.4V	3.0V	3.2V	3.4V
Delivered lumens** (L ₁₀₀)	107	146	195	130	177	237
Lumens per circuit watt	89	86	81	108	104	99

LED lifetime (to 70% lumen maintenance) 50,000hrs at a max ambient temperature of 35°C (if specifying fitting in ambient temperatures of up to 45°C run at 500mA max, LD81-500)

Materials

Anodised aluminium body

Wiring

Comes pre-wired with 2 core 120mm lead, can be specified with up to 10m at extra cost

IP rating

IP40

*LED wattage includes losses associated with using an 85% efficient driver

** 2700K lumen output is 12% lower than the 3000K figure listed

4000K lumen output is 14% higher than the 3000K figure listed (80 CRI)

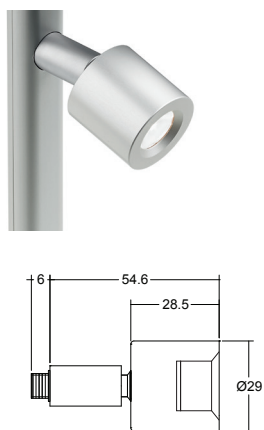

LD82 - For a single spotlight on top of a stem, see our LD82 which has the knuckle joint on the side. This uses the same LED and optics as the LD81. Please see our website for more details

LD81



High Power Miniature LED spotlight with Mounting Systems

Data sheet - Page 2

Mounting Options and Dimensions

Stem Mounting Methods - This 2 part aluminium profile has been designed as a slight oval and is counterbored where the knuckles attach which gives a slim look and neat detail at the junction. The best method of specification is to send us a sketch of what is required, this can then be discussed and a project quote created. 4 mounting methods are available and each is custom made to the specification.

/M1

Method 1 - for fixing to the base of a cabinet, with cables exiting from the M8 all-thread stud. Specify stem length, number of spotlights and spacing.

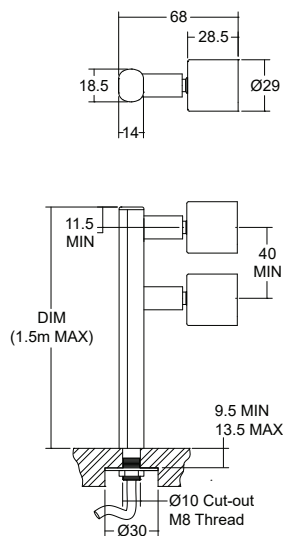

/M1D

Method 1 Double - this uses the same mounting method as /M1 with the addition of opposing light sources. Specify stem length, number of spotlights and spacing.

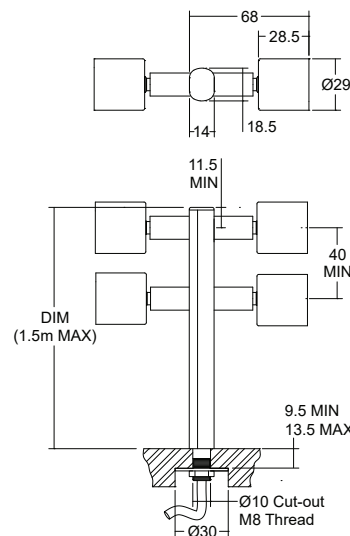

/M2

Method 2 - surface mounted option with cable exit at the back. Specify stem length, number of spotlights and spacing.

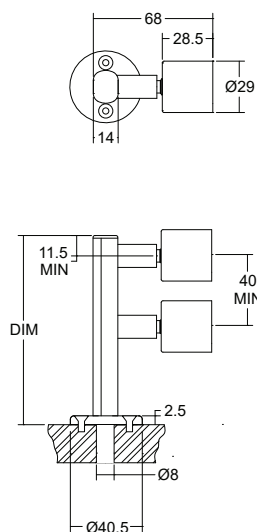

/M2D

Method 2 Double - this uses the same surface mounting method as /M2 with the addition of opposing light sources. Specify stem length, number of spotlights and spacing.

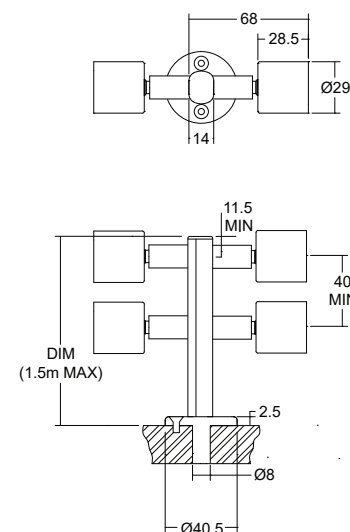

LD81



High Power Miniature LED spotlight with Mounting Systems

Data sheet - Page 3

/M3

Method 3 - stem is fixed at the bottom with a surface mount base and screws. An M8 thread and nut is used to fix at the top. Specify stem length, number of spotlights and spacing.

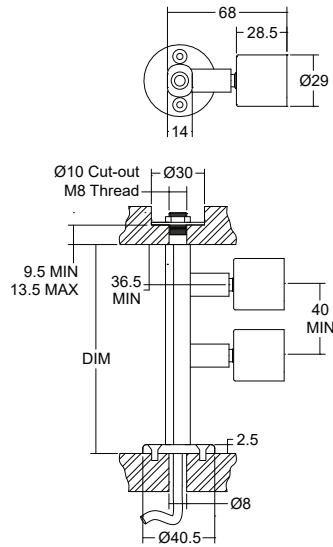

/M3D

Method 3 Double - this uses the same surface mounting method as /M3 with the addition of opposing light sources. Specify stem length, number of spotlights and spacing.

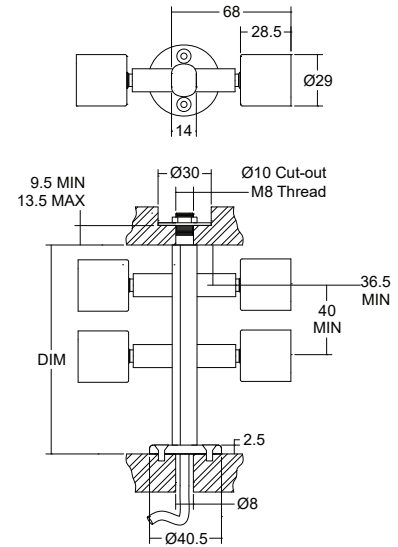

/M4

Method 4 - goal post method. Specify stem and leg support length, LED spacing and number of spots.

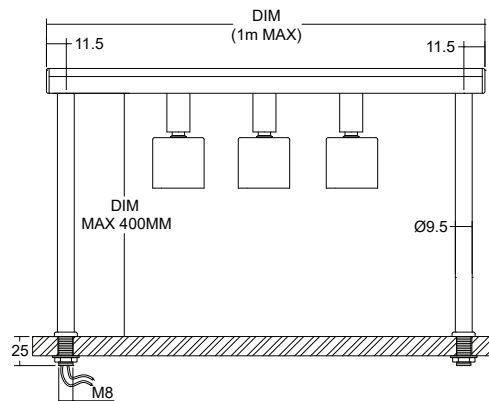

LD81



High Power Miniature LED spotlight with Mounting Systems

Data sheet - Page 4

Alternative Mounting Methods

/E1313

Aluminium U channel can be flush mounted into a routed groove into the side of cabinets which makes a very neat detail. All the wiring can be done at the manufacturing stage speeding up installation. Specify length, number of spotlights and spacing.

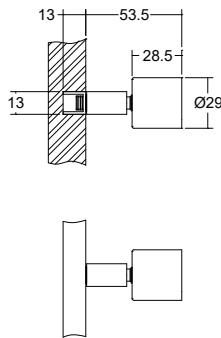

Order Codes and Options

Product code	LED colour	Beam angle	Finish	Mounting method	Length
LD81 - 350 - 500 - 700	<input type="text"/>	<input type="text"/>	<input type="text"/>	<input type="text"/>	<input type="text"/>

Example: LD81-700 / LW30 / MB / Silver / M1 / 500mm

Product codes with output options

1.2W LED at 350mA	LD81-350
1.7W LED at 500mA	LD81-500
2.4W LED at 700mA	LD81-700

LED colour options

LED colour options	Suffix
Super Warm White (2200K)	/LW22
Extra Warm White (2700K)	/LW27
Warm White (3000K)	/LW30
White (4000K) - on request	/LW40
Cool White (5000K)	/LW50

*Other LED colour temperatures are available. Please speak to a member of our sales team.

Beam / lens angle options

12° narrow spot	/NB
31° medium	/MB
48° wide	/WB

Finish options

Paint finish silver / black / white (RAL 9016) / antique bronze / satin antique brass / satin brass / RAL finish

Mounting method and accessories

Method 1	/M1
Method 1 Double	/M1D
Method 2	/M2
Method 2 Double	/M2D
Method 3	/M3
Method 3 Double	/M3D
Method 4	/M4
Aluminium U channel	/E1313
Single swivel mounting plate	/PL1
Cowl	/CO

Use with 350mA, 500mA or 700mA constant current LED drivers

We have a wide range of dimmable LED drivers, 0-10V, DMX, DALI and Mains dimmable. Please see the downloads section on our website:

To run 1-14 LD81-350 in series use a TXDEL350D (0-10V dimmable)

To run 1-14 LD81-500 in series use a TXDEL500D (0-10V dimmable)

To run 1-13 LD81-700 in series use a TXDEL700D (0-10V dimmable)

/PL1

Single swivel mounting plate is very useful for mounting individual spotlights neatly into the sides, top or base of cabinets.

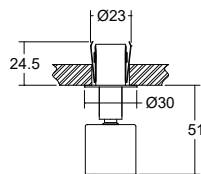

Accessories

/CO - Anti Glare Cowl

The cowl is securely fitted to the LD81 with the aid of an O-ring.

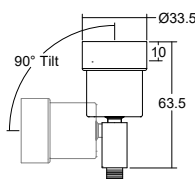

Photometrics

Photometric files are included in the design pack which can be downloaded from the LD81 product page on the website.